



Installation instructions for PZ4AL- 01189- 00

Lexus LS 460, Lexus LS 460 L

Under Run Protective Shield transmission case



Model Year:	LS 460 - 2009	LS 460L - 2009
Vehicle Code:	USF40L-AEZGHW	USF41L-AEZGHW
Part Number:	PZ4AL-01189-00	PZ4AL-01189-00
 Weight:	3,8 kg	3,8 kg
 Installation Time:	15 min	15 min
Manual reference number:	AIM 002 019	AIM 002 019

Part number: PZ4AL-01189-00

A

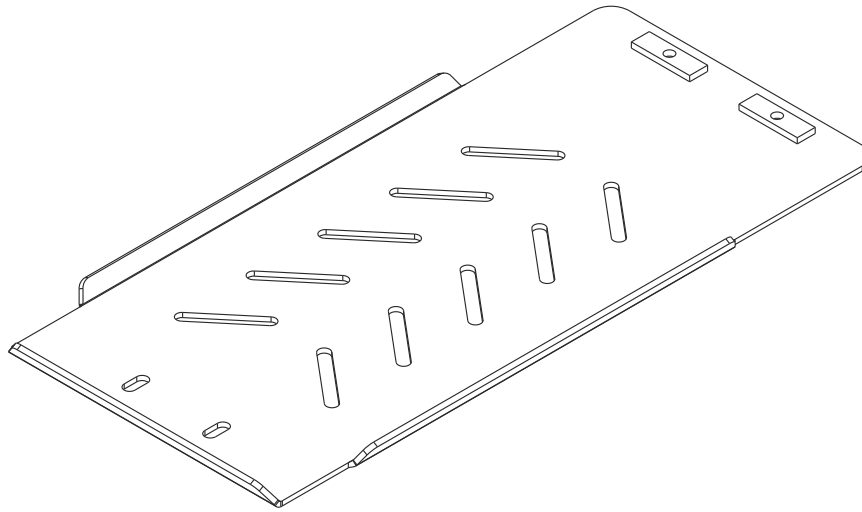

PZ4AL-01189-60

B

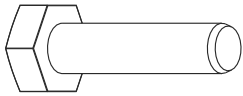

4 x M 10x1,25x40

C

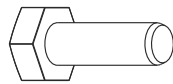

4 x M 10x30

D

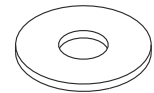

6 x Ø 10

E

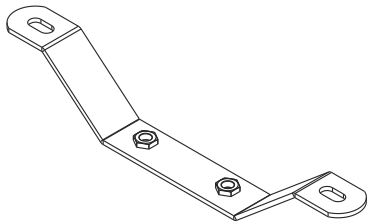

1 x

F

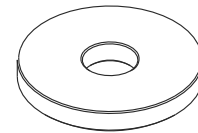

2 x SD 7001

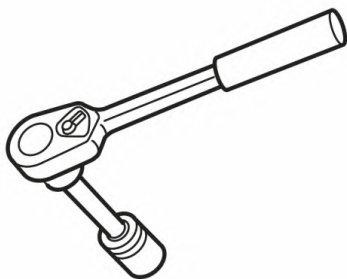

Part number:
PZ4AL-01189-00

Issue:
0

Date:
24/02/09

Manual reference number:
AIM 002 019

Page:
2/4

1

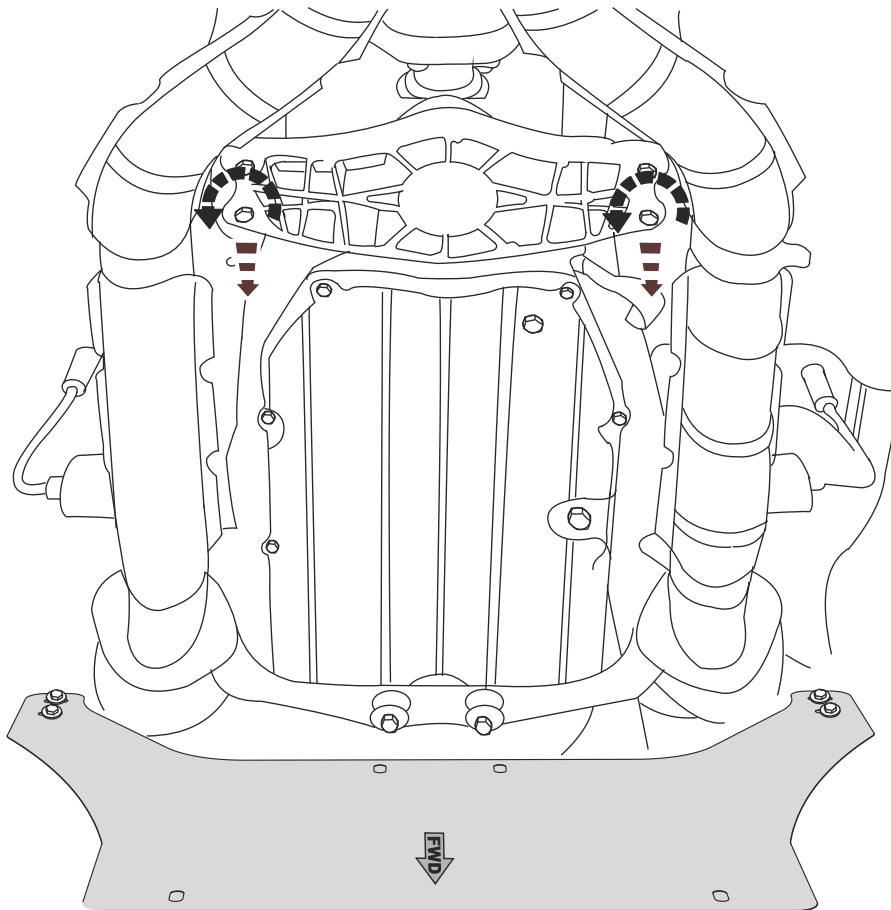

2

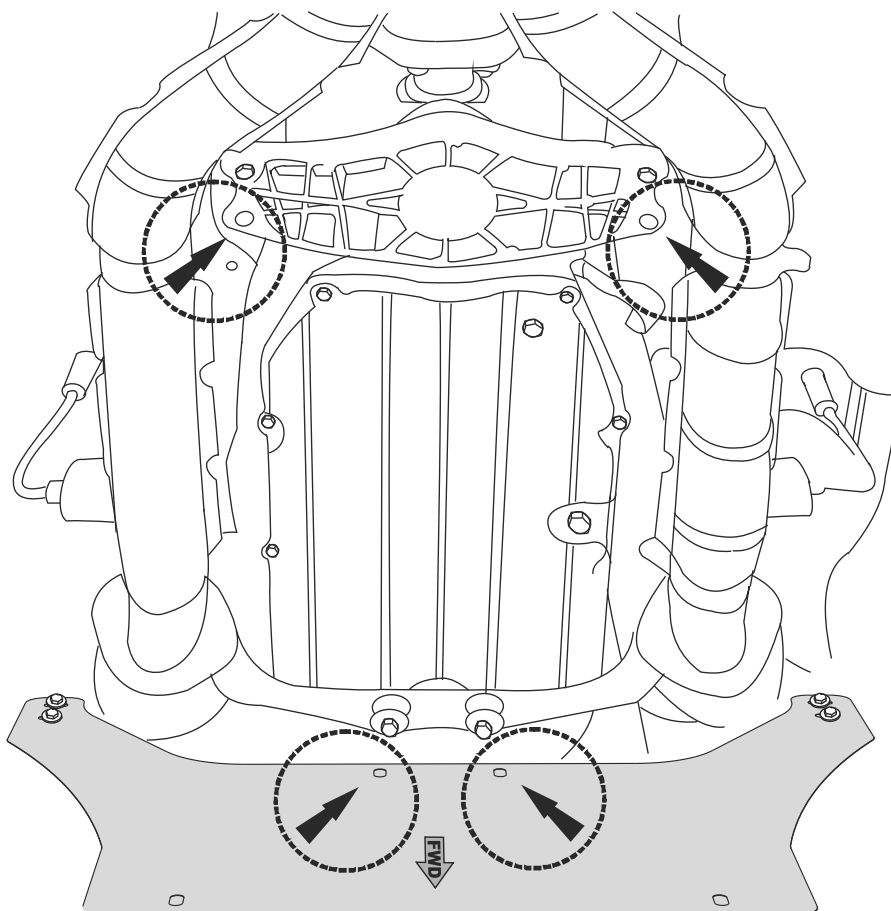

3

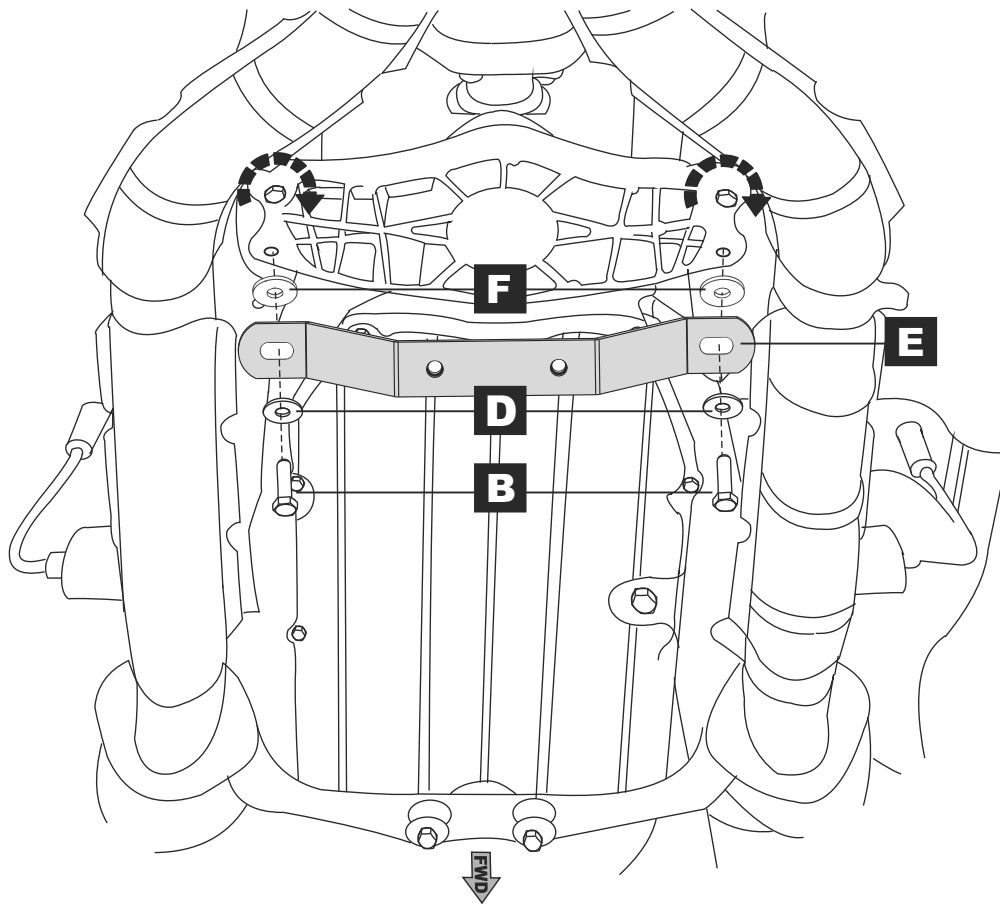

4

